

Table of Contents

Table of Contents	1
Introduction	2
Design Considerations	3
Part Number Identification	5
Shape and Dimensions	6
Recommended Land Patterns	6
ES Series	7
HA Series	9
NA Series	11
Terms and Definitions	14
Reliability Tests	15
Packaging	16
Recommended Soldering Temperature Profiles	17

Introduction

AEM Surface Mount Multilayer Varistors (MLV) are manufactured with zinc oxide base semi-conductive ceramics using multilayer co-firing technology. They offer reliable protection against ESD and transient over-voltage surges. Standard EIA sizes from 0402 to 2220 are available.

Three series are offered for different applications.

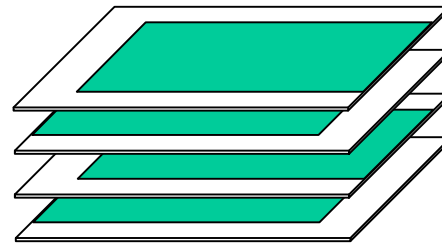
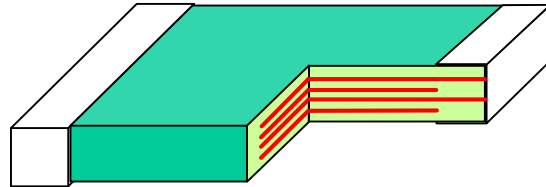

Multilayer structure

Series	Application	Working Voltage (DC)	Size
HA	High Surge	11—45V	1206,1210,1812,2220
NA	Normal Surge	3.3—127V	0402,0603,0805,1206,1210,1812,2220
ES	Electro-Static Discharge	5-24V	0402,0603

Design Considerations

1. Voltage Dependent Characteristics

Transient Voltage Suppressors (TVS) are voltage-dependent variable resistors with symmetrical V/I characteristics. MLV is one type of TVS. Their resistance decreases with increasing voltage, similar to “short-circuit” under over-voltage conditions.

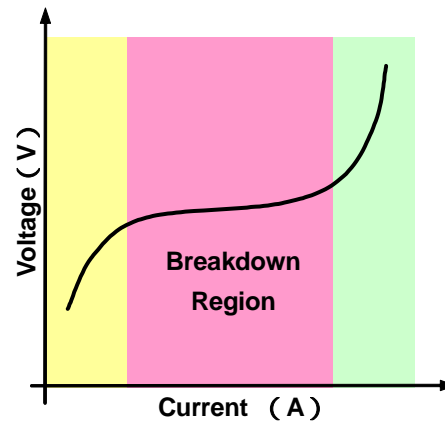

2. Protection of Over-voltage

When transient over-voltage is higher than the breakdown voltage of the TVS, the resistance of the suppressor will decrease sharply and significant amount of current will bypass through the TVS. As a result, the over-voltage is considerably attenuated. The circuit is protected from the damage of transient over-voltage.

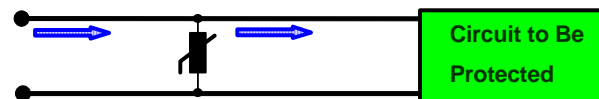

Normal Condition

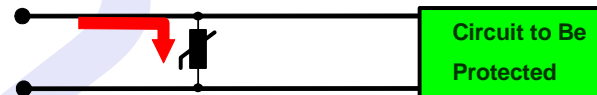

Over-voltage Condition

Following parameters should be considered when selecting TVS to meet the circuit protection requirements.

1. The surge handling capability of the selected TVS should be high enough to dissipate the anticipated transient surge energy.
2. The clamping voltage of the selected TVS should be lower than the maximum operating voltage of the protected circuit.
3. In a high speed data transmission circuit, the capacitance of the selected TVS should be considered for the attenuation of a high speed signal.
4. The working voltage of the TVS should be greater than the normal operating voltage of the circuit.

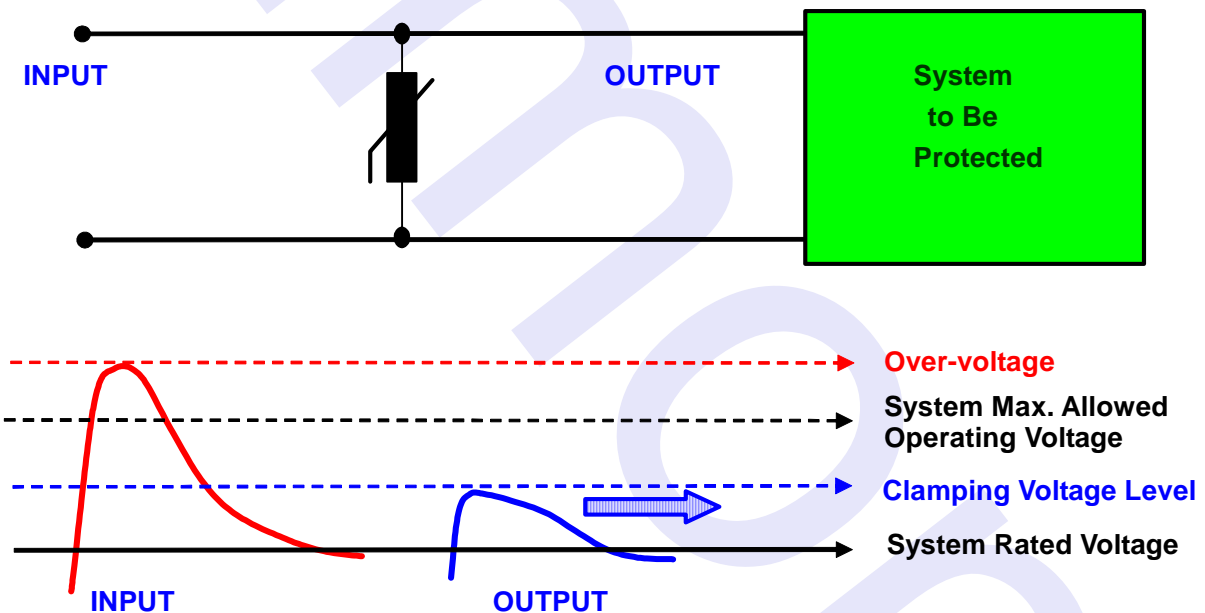

Over-voltage Protection by Using Varistor

Part Number Identification

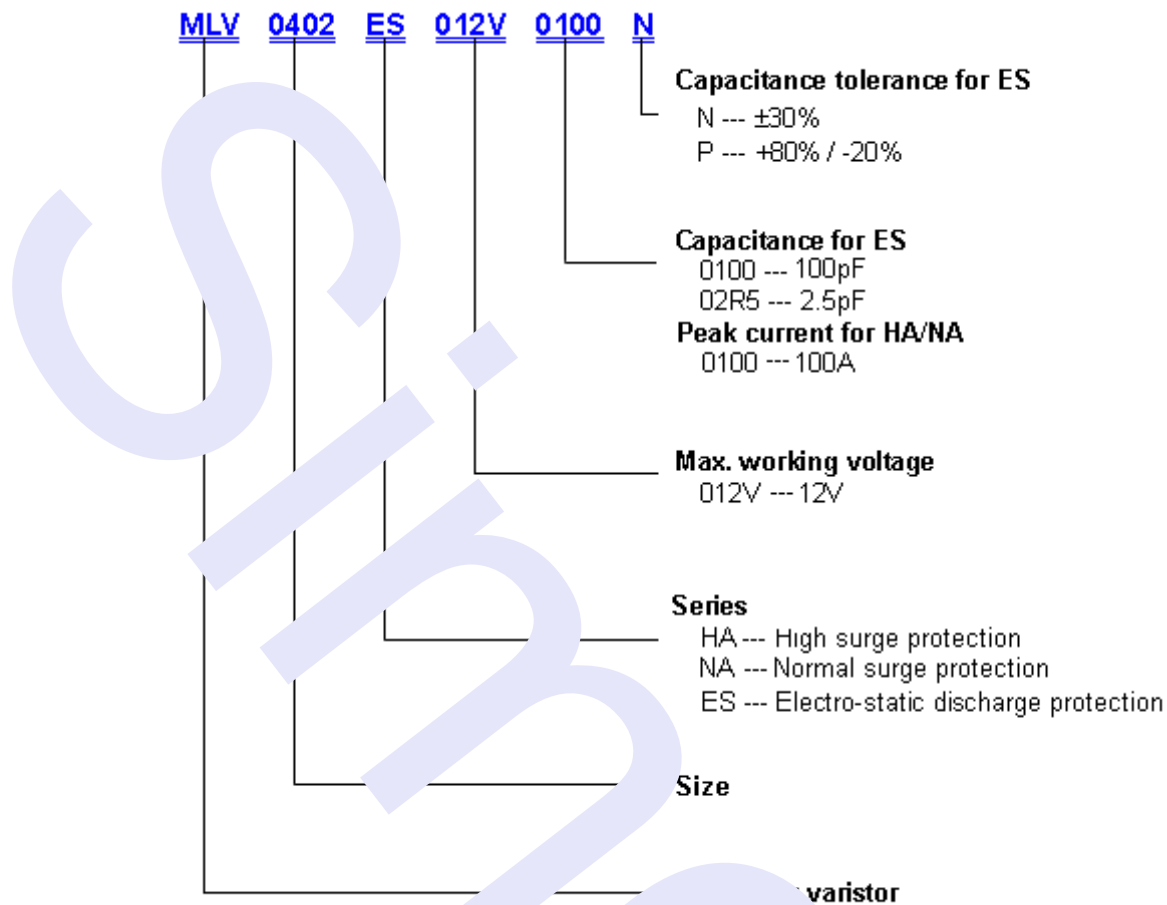

Operating Temperature Ranges:

- 55°C to +85°C for size 0603 or smaller
- 55°C to +125°C for size 0805 or larger

Shape and Dimensions

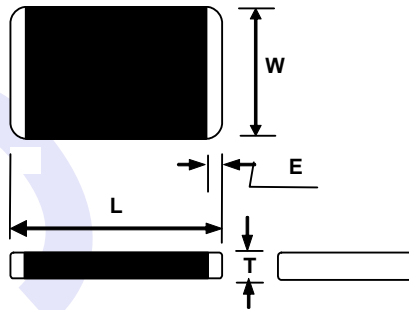

Size	L (mm)	W (mm)	T (mm)	E (mm)
0402	1.00 ± 0.10	0.50 ± 0.10	0.60 max.	0.25 +0.10/-0.10
0603	1.60 ± 0.15	0.80 ± 0.10	0.90 max.	0.30 +0.10/-0.10
0805	2.00 ± 0.20	1.25 ± 0.15	1.00 max.	0.30 +0.10/-0.10
1206	3.20 ± 0.20	1.60 ± 0.15	1.50 max.	0.50 +0.20/-0.20
1210	3.20 ± 0.20	2.50 ± 0.20	1.50 max.	0.50 +0.20/-0.20
1812	4.50 ± 0.20	3.20 ± 0.20	2.00 max.	0.50 +0.30/-0.10
2220	5.70 ± 0.20	5.00 ± 0.20	2.50 max.	0.50 +0.30/-0.10

Recommended Land Patterns

Size	Solder pad layout			
	A (mm)	B (mm)	C (mm)	D (mm)
0402	0.4~0.6	1.4~1.8	0.5~0.6	0.6~1.2
0603	0.8~1.2	2.2~2.8	0.6~1.0	0.9~1.5
0805	1.0~1.5	2.6~3.2	1.2~1.5	1.1~1.8
1206	1.8~2.5	4.2~5.2	1.2~1.8	1.2~1.8
1210	1.8~2.5	4.2~5.2	2.2~3.0	1.3~2.0
1812	2.5~3.3	5.5~6.7	2.8~3.6	1.3~2.2
2220	3.8~4.6	6.6~7.8	4.8~5.5	1.3~2.2

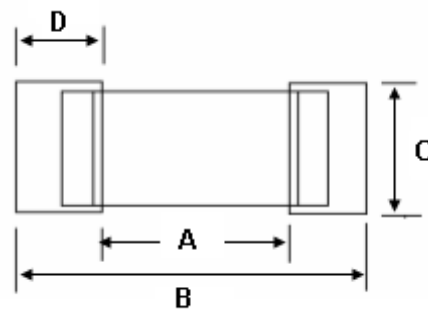

ES Series

Part Number	Working Voltage (max)	Clamping Voltage (max)	Leakage Current	Cap.	Tolerance of Cap.
	DC (V)	(V)	I_{LDC} (μ A)	(pF)	(%)
MLV0402ES005V0100N	5	28	0.1	100	± 30
MLV0402ES005V0082N	5	35	0.1	82	± 30
MLV0402ES005V0056N	5	35	0.1	56	± 30
MLV0402ES005V0033N	5	35	0.1	33	± 30
MLV0402ES005V0022N	5	35	0.1	22	± 30
MLV0402ES005V0010N	5	50	0.1	10	± 30
MLV0402ES005V0005P	5	45	0.1	5	+80 / -20
MLV0402ES012V0100N	12	35	0.1	100	± 30
MLV0402ES012V0082N	12	45	0.1	82	± 30
MLV0402ES012V0056N	12	45	0.1	56	± 30
MLV0402ES012V0033N	12	45	0.1	33	± 30
MLV0402ES012V0022N	12	45	0.1	22	± 30
MLV0402ES012V0010N	12	60	0.1	10	± 30
MLV0402ES012V0005P	12	65	0.1	5	+80 / -20
MLV0402ES024V02R5P	24	200	0.1	2.5	+80 / -20
MLV0603ES005V0100N	5	28	0.1	100	± 30
MLV0603ES005V0082N	5	35	0.1	82	± 30
MLV0603ES005V0056N	5	35	0.1	56	± 30
MLV0603ES005V0033N	5	35	0.1	33	± 30
MLV0603ES005V0022N	5	35	0.1	22	± 30
MLV0603ES005V0010N	5	50	0.1	10	± 30
MLV0603ES005V0005P	5	50	0.1	5	+80 / -20
MLV0603ES012V0100N	12	40	0.1	100	± 30
MLV0603ES012V0082N	12	45	0.1	82	± 30
MLV0603ES012V0056N	12	45	0.1	56	± 30
MLV0603ES012V0033N	12	45	0.1	33	± 30
MLV0603ES012V0022N	12	45	0.1	22	± 30
MLV0603ES012V0010N	12	60	0.1	10	± 30
MLV0603ES012V0005P	12	72	0.1	5	+80 / -20
MLV0603ES024V02R5P	24	200	0.1	2.5	+80 / -20

ES Series

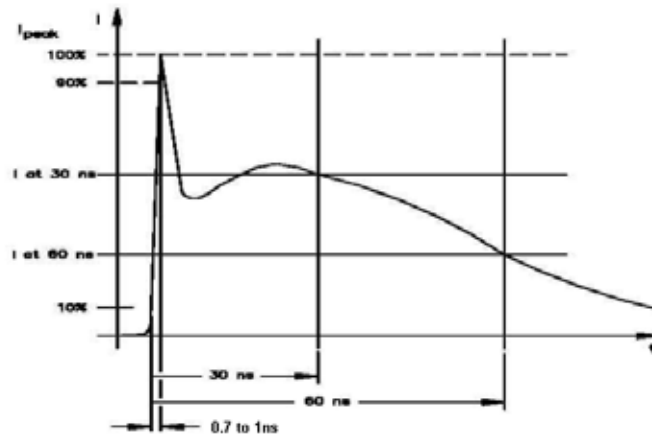

IEC 61000-4-2 Compliant ESD Current Pulse Waveform

IEC61000-4-2 Standards

Severity Level	Air Discharge	Direct Discharge
1	2 KV	2 KV
2	4 KV	4 KV
3	8 KV	6 KV
4	15 KV	8 KV

Reference Data

Maximum Energy Absorption	E < 0.05 J (0402) E < 0.1 J (0603)
Response time	T _{rise} < 1ns
Leakage current at V _v × 80%(At initial state)	I _{Vv} < 50μA
Leakage current at V _v × 80% (After reliability Test)	I _{VvA} < 200μA

HA Series

Part Number	Working Voltage (max)		Breakdown Voltage	Peak Current (max)	Clamping Voltage (max)		Energy Absorption (max)	Typical Capacitance
	AC (V _{RMS})	DC (V)			1mA (V)	8/20 μ s (A)		
MLV1206HA011V0200	8	11	15(12.8~17.3)	200	1	25	0.4	1700
MLV1206HA014V0200	11	14	18(15.3~20.7)	200	1	30	0.5	1500
MLV1206HA017V0200	12	16.5	22(19.8~24.2)	200	1	36	0.5	1280
MLV1206HA018V0200	14	18	24(21.6~26.4)	200	1	39	0.5	1160
MLV1206HA022V0200	17	22	27(24.3~29.7)	200	1	44	0.6	1080
MLV1206HA026V0200	20	26	33(29.7~36.3)	200	1	54	0.7	680
MLV1206HA030V0200	25	30	39(35.1~42.9)	200	1	65	1.0	620
MLV1206HA038V0200	30	38	47(42.3~51.7)	200	1	77	1.1	550
MLV1206HA045V0200	35	45	56(50.4~61.6)	200	1	90	0.8	400
MLV1210HA011V0400	8	11	15(12.8~17.3)	400	2.5	25	1.0	4050
MLV1210HA014V0400	11	14	18(15.3~20.7)	400	2.5	30	1.2	3860
MLV1210HA017V0400	12	16.5	22(19.8~24.2)	400	2.5	36	1.4	2600
MLV1210HA018V0400	14	18	24(21.6~26.4)	400	2.5	39	1.4	2380
MLV1210HA022V0400	17	22	27(24.3~29.7)	400	2.5	44	1.7	2100
MLV1210HA026V0400	20	26	33(29.7~36.3)	400	2.5	54	1.9	1400
MLV1210HA030V0400	25	30	39(35.1~42.9)	400	2.5	65	1.7	1180
MLV1210HA038V0400	30	38	47(42.3~51.7)	400	2.5	77	2.0	1000
MLV1210HA045V0400	35	45	56(50.4~61.6)	400	2.5	90	2.0	660
MLV1812HA011V0800	8	11	15(12.8~17.3)	800	5	25	1.8	8450
MLV1812HA014V0800	11	14	18(15.3~20.7)	800	5	30	1.9	7030
MLV1812HA017V0800	12	16.5	22(19.8~24.2)	800	5	36	2.3	5080
MLV1812HA018V0800	14	18	24(21.6~26.4)	800	5	38	2.3	4650
MLV1812HA022V0800	17	22	27(24.3~29.7)	800	5	44	2.7	4150
MLV1812HA026V0800	20	26	33(29.7~36.3)	800	5	54	3.0	3400
MLV1812HA030V0800	25	30	39(35.1~42.9)	800	5	65	3.7	2950
MLV1812HA038V0800	30	38	47(42.3~51.7)	800	5	77	4.2	2550
MLV1812HA045V0800	35	45	56(50.4~61.6)	800	5	90	4.2	2400

HA Series

Part Number	Working Voltage (max)		Breakdown Voltage	Peak Current (max)	Clamping Voltage (max)		Energy Absorption (max)	Typical Capacitance
	AC (V _{RMS})	DC (V)			1mA (V)	8/20 μ s (A)		
MLV2220HA011V1200	8	11	15(12.8~17.3)	1200	10	25	4.2	21200
MLV2220HA014V1200	11	14	18(15.3~20.7)	1200	10	30	5.4	17700
MLV2220HA017V1200	12	16.5	22(19.8~24.2)	1200	10	36	5.8	14500
MLV2220HA018V1200	14	18	24(21.6~26.4)	1200	10	39	5.8	13600
MLV2220HA022V1200	17	22	27(24.3~29.7)	1200	10	44	7.2	12000
MLV2220HA026V1200	20	26	33(29.7~36.3)	1200	10	54	7.8	10500
MLV2220HA030V1200	25	30	39(35.1~42.9)	1200	10	65	9.6	8900
MLV2220HA038V1200	30	38	47(42.3~51.7)	1200	10	77	12.0	5700
MLV2220HA045V1200	35	45	56(50.4~61.6)	1200	10	90	7.7	4800

NA Series

Part Number	Working Voltage (max)		Breakdown Voltage	Peak Current (max)	Clamping Voltage (max)		Energy Absorption (max)	Typical Capacitance
	AC (V _{RMS})	DC (V)	1mA (V)	8/20 μ s (A)	(A)	(V)	10/1000 μ s (J)	1KHz (pF)
MLV0402NA003V0020	2.5	3.3	5(4.0~6.0)	20	1	10	0.05	390
MLV0402NA006V0020	4	5.5	8(6.4~9.6)	20	1	16	0.05	295
MLV0402NA009V0020	6	9	12(10.2~13.8)	20	1	20	0.05	190
MLV0402NA011V0020	8	11	15(12.8~17.3)	20	1	25	0.05	160
MLV0402NA014V0020	11	14	18(16.2~19.8)	20	1	30	0.05	135
MLV0402NA017V0020	12	16.5	22(19.8~24.2)	20	1	36	0.05	105
MLV0402NA018V0020	14	18	24(21.6~26.4)	20	1	40	0.05	93
MLV0402NA022V0020	17	22	27(24.3~29.7)	20	1	45	0.05	75
MLV0402NA026V0020	20	26	33(29.7~36.3)	20	1	54	0.05	54
MLV0402NA030V0020	25	30	39(35.1~42.9)	20	1	65	0.05	45
MLV0402NA038V0020	30	38	47(42.3~51.7)	20	1	77	0.05	27
MLV0603NA003V0030	2.5	3.3	5(4.0~6.0)	30	1	10	0.1	1250
MLV0603NA006V0030	4	5.5	8(6.4~9.6)	30	1	16	0.1	800
MLV0603NA009V0030	6	9	12(10.2~13.8)	30	1	20	0.1	680
MLV0603NA011V0030	8	11	15(12.8~17.3)	30	1	25	0.1	460
MLV0603NA014V0030	11	14	18(16.2~19.8)	30	1	30	0.1	350
MLV0603NA017V0030	12	16.5	22(19.8~24.2)	30	1	36	0.1	300
MLV0603NA018V0030	14	18	24(21.6~26.4)	30	1	39	0.1	270
MLV0603NA022V0030	17	22	27(24.3~29.7)	30	1	44	0.1	235
MLV0603NA026V0030	20	26	33(29.7~36.3)	30	1	54	0.1	200
MLV0603NA030V0030	25	30	39(35.1~42.9)	30	1	65	0.1	120
MLV0603NA038V0030	30	38	47(42.3~51.7)	30	1	77	0.1	100
MLV0603NA045V0030	35	45	56(50.4~61.6)	30	1	90	0.1	80
MLV0805NA003V0040	2.5	3.3	5(4.0~6.0)	40	1	10	0.1	2450
MLV0805NA006V0080	4	5.5	8(6.4~9.6)	80	1	16	0.1	1600
MLV0805NA009V0080	6	9	12(10.2~13.8)	80	1	20	0.1	1180
MLV0805NA011V0100	8	11	15(12.8~17.3)	100	1	25	0.1	1050
MLV0805NA014V0100	11	14	18(16.2~19.8)	100	1	30	0.1	750
MLV0805NA017V0100	12	16.5	22(19.8~24.2)	100	1	36	0.2	680
MLV0805NA018V0100	14	18	24(21.6~26.4)	100	1	39	0.2	550
MLV0805NA022V0100	17	22	27(24.3~29.7)	100	1	44	0.2	400
MLV0805NA026V0100	20	26	33(29.7~36.3)	100	1	54	0.3	350

NA Series

Part Number	Working Voltage (max)		Breakdown Voltage	Peak Current (max)	Clamping Voltage (max)		Energy Absorption (max)	Typical Capacitance
	AC (V _{RMS})	DC (V)	1mA (V)	8/20 μ s (A)	(A)	(V)	10/1000 μ s (J)	1KHz (pF)
MLV0805NA030V0100	25	30	39(35.1~42.9)	100	1	65	0.3	310
MLV0805NA038V0100	30	38	47(42.3~51.7)	100	1	77	0.3	280
MLV0805NA045V0080	35	45	56(50.4~61.6)	80	1	90	0.3	195
MLV0805NA056V0080	40	56	68(61.2~74.8)	80	1	110	0.3	145
MLV0805NA065V0060	50	65	82(73.8~90.2)	60	1	135	0.3	85
MLV1206NA003V0060	2.5	3.3	5(4.0~6.0)	60	1	10	0.1	3850
MLV1206NA006V0100	4	5.5	8(6.4~9.6)	100	1	16	0.2	3200
MLV1206NA009V0100	6	9	12(10.2~13.8)	100	1	20	0.2	2200
MLV1206NA011V0100	8	11	15(12.8~17.3)	100	1	25	0.2	1300
MLV1206NA014V0100	11	14	18(16.2~19.8)	100	1	30	0.3	1150
MLV1206NA017V0100	12	16.5	22(19.8~24.2)	100	1	36	0.3	1000
MLV1206NA018V0100	14	18	24(21.6~26.4)	100	1	38	0.3	900
MLV1206NA022V0100	17	22	27(24.3~29.7)	100	1	44	0.4	840
MLV1206NA026V0100	20	26	33(29.7~36.3)	100	1	54	0.5	490
MLV1206NA030V0100	25	30	39(35.1~42.9)	100	1	65	0.6	440
MLV1206NA038V0100	30	38	47(42.3~51.7)	100	1	77	0.7	400
MLV1206NA045V0100	35	45	56(50.4~61.6)	100	1	90	0.8	310
MLV1206NA056V0100	40	56	68(61.2~74.8)	100	1	110	1.0	280
MLV1206NA065V0100	50	65	82(73.8~90.2)	100	1	135	0.5	240
MLV1206NA085V0100	60	85	100(90.0~110.0)	100	1	165	0.6	160
MLV1206NA090V0100	70	90	110(99.0~121.0)	100	1	180	0.6	120
MLV1210NA006V0250	4	5.5	8(6.4~9.6)	250	2.5	16	0.4	6200
MLV1210NA009V0250	6	9	12(10.2~13.8)	250	2.5	20	0.5	4400
MLV1210NA011V0250	8	11	15(12.8~17.3)	250	2.5	25	0.6	3520
MLV1210NA014V0250	11	14	18(16.2~19.8)	250	2.5	30	0.7	3260
MLV1210NA017V0250	12	16.5	22(19.8~24.2)	250	2.5	36	0.8	2100
MLV1210NA018V0250	14	18	24(21.6~26.4)	250	2.5	38	0.8	1950
MLV1210NA022V0250	17	22	27(24.3~29.7)	250	2.5	44	1.0	1720
MLV1210NA026V0250	20	26	33(29.7~36.3)	250	2.5	54	1.2	1090
MLV1210NA030V0250	25	30	39(35.1~42.9)	250	2.5	65	1.4	920
MLV1210NA038V0250	30	38	47(42.3~51.7)	250	2.5	77	1.6	780
MLV1210NA045V0250	35	45	56(50.4~61.6)	250	2.5	90	2.0	470
MLV1210NA056V0250	40	56	68(61.2~74.8)	250	2.5	110	2.3	390

NA Series

Part Number	Working Voltage (max)		Breakdown Voltage	Peak Current (max)	Clamping Voltage (max)		Energy Absorption (max)	Typical Capacitance
	AC (V _{RMS})	DC (V)	1mA (V)	8/20 μ s (A)	(A)	(V)	10/1000 μ s (J)	1KHz (pF)
MLV1210NA065V0250	50	65	82(73.8~90.2)	250	2.5	135	1.2	320
MLV1210NA085V0200	60	85	100(90.0~110.0)	200	2.5	165	1.4	220
MLV1210NA090V0200	70	90	110(99.0~121.0)	200	2.5	180	1.4	200
MLV1812NA009V0500	6	9	12(10.2~13.8)	500	5	20	0.9	9150
MLV1812NA011V0500	8	11	15(12.8~17.3)	500	5	25	1.2	7320
MLV1812NA014V0500	11	14	18(16.2~19.8)	500	5	30	1.4	6100
MLV1812NA017V0500	12	16.5	22(19.8~24.2)	500	5	36	1.6	4300
MLV1812NA018V0500	14	18	24(21.6~26.4)	500	5	38	1.7	3930
MLV1812NA022V0500	17	22	27(24.3~29.7)	500	5	44	2.0	3500
MLV1812NA026V0500	20	26	33(29.7~36.3)	500	5	54	2.5	2900
MLV1812NA030V0500	25	30	39(35.1~42.9)	500	5	65	2.9	2500
MLV1812NA038V0500	30	38	47(42.3~51.7)	500	5	77	3.5	2200
MLV1812NA045V0500	35	45	56(50.4~61.6)	500	5	90	4.2	1950
MLV1812NA056V0500	40	56	68(61.2~74.8)	500	5	110	4.8	1650
MLV1812NA065V0400	50	65	82(73.8~90.2)	400	5	135	4.5	1060
MLV1812NA085V0400	60	85	100(90.0~110.0)	400	5	165	5.8	870
MLV1812NA090V0400	70	90	110(99.0~121.0)	400	5	180	5.8	790
MLV1812NA127V0300	95	127	150(135.0~165.0)	300	5	248	5.8	420
MLV2220NA009V1000	6	9	12(10.2~13.8)	1000	10	20	1.9	36500
MLV2220NA011V1000	8	11	15(12.8~17.3)	1000	10	25	2.3	18400
MLV2220NA014V1000	11	14	18(16.2~19.8)	1000	10	30	2.7	15300
MLV2220NA017V1000	12	16.5	22(19.8~24.2)	1000	10	36	2.9	12500
MLV2220NA018V1000	14	18	24(21.6~26.4)	1000	10	38	3.1	11800
MLV2220NA022V1000	17	22	27(24.3~29.7)	1000	10	44	3.8	10400
MLV2220NA026V1000	20	26	33(29.7~36.3)	1000	10	54	4.3	8900
MLV2220NA030V1000	25	30	39(35.1~42.9)	1000	10	65	5.5	7500
MLV2220NA038V1000	30	38	47(42.3~51.7)	1000	10	77	6.3	4600
MLV2220NA045V1000	35	45	56(50.4~61.6)	1000	10	90	7.7	4000
MLV2220NA056V1000	40	56	68(61.2~74.8)	1000	10	110	8.8	3500
MLV2220NA065V0800	50	65	82(73.8~90.2)	800	10	135	5.6	2850
MLV2220NA085V0800	60	85	100(90.0~110.0)	800	10	165	6.8	1800
MLV2220NA090V0800	70	90	110(99.0~121.0)	800	10	180	6.8	1500

HA/NA 8/20 μ s waveform

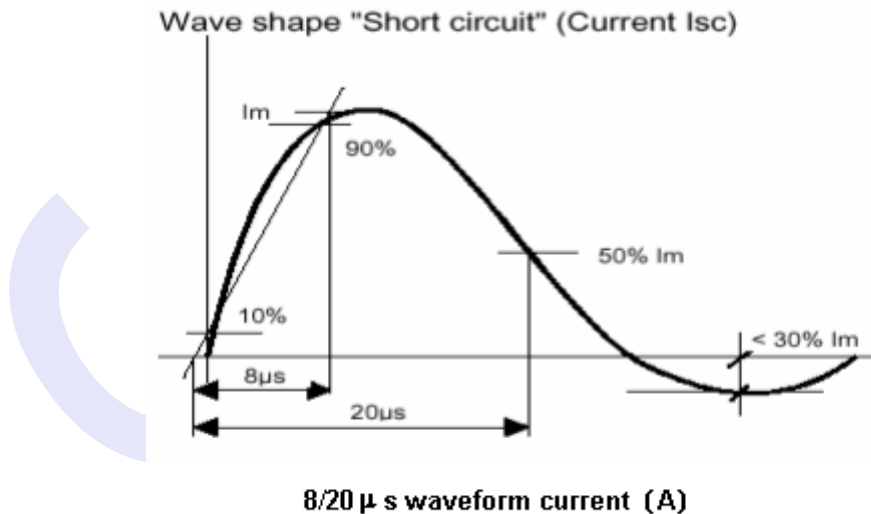

Terms and Definitions

Term	Definition
Max. Working Voltage	Maximum steady-state DC operating voltage with typical leakage current less than 50 μ A at 25
Varistor Voltage (BDV)	Breakdown DC voltage measured at current of 1mA
Max. Clamping Voltage	Maximum peak voltage across the part, measured at a specified pulse current and waveform
Surge Current	Maximum peak current with the specified 8/20 μ s waveform without damage
Surge Shift V/V	The change of varistor voltage after applying the specified surge current
Energy Absorption	Maximum energy may be dissipated with a specified 10/1000 μ s waveform without damage
Typical Capacitance	Capacitance measured with voltage bias less than 0.5V _{RMS} at 1KHz
Nonlinear Exponent	$= [\log (V_{1mA} / V_{0.1mA}) / \log (I_{V1mA} / I_{V0.1mA})]$
Leakage Current	Measured at working voltage

Reliability Tests

No.	Test	Requirement	Test condition	Test reference
1	Soldering heat resistance	BDV change $\leq \pm 10\%$ No mechanical damage	One dip at 260 for 5 sec.	MIL-STD-202 Method 215 IEC 60068-2-20
2	Solderability	New solder coverage $\geq 75\%$	One dip at 235 for 5 sec. Non-active flux	MIL-STD-202 Method 210 IEC 60068-2-20
3	Maximum surge current	BDV change $\leq \pm 10\%$ No mechanical damage	100 pulses of 8/20 μs with maximum surge current and 30 sec. interval at 25 and 30~65% RH	CECC 42000 IEC 1051-1 Test 4.5
4	Maximum surge energy	BDV change $\leq \pm 10\%$ No mechanical damage	100 pulses of 10/1000 μs with maximum surge current and 90 sec. interval at 25 and 30~65% RH	CECC 42000
5	Thermal cycling	BDV change $\leq \pm 10\%$ No mechanical damage Leakage current $\leq 200 \mu\text{A}$	5 cycles between -40 and 125 with 30 min. dwell time at the temperature extremes and 60 min. dwell time at 25	CECC 42000 IEC 60068-2-14
6	Low temperature resistance	BDV change $\leq \pm 10\%$ No mechanical damage Leakage current $\leq 200 \mu\text{A}$	1000 hr at -50	IEC 60068-2-1
7	Low temperature load resistance	BDV change $\leq \pm 10\%$ No mechanical damage Leakage current $\leq 200 \mu\text{A}$	1000 hr at -50 with working voltage applied	IEC 60068-2-1
8	High temperature resistance	BDV change $\leq \pm 10\%$ No mechanical damage Leakage current $\leq 200 \mu\text{A}$	1000 hr at 150	MIL-STD-202 Method 108 CECC 42000
9	High temperature load resistance	BDV change $\leq \pm 10\%$ No mechanical damage Leakage current $\leq 200 \mu\text{A}$	1000 hr at 85 with working voltage applied	CECC 42000
10	Humidity resistance	BDV change $\leq \pm 10\%$ No mechanical damage Leakage current $\leq 200 \mu\text{A}$	500 hr at 40 and 90~95% RH	MIL-STD-202 Method 106 IEC 60068-2-3 CECC 42000;
11	Humidity load resistance	BDV change $\leq \pm 10\%$ No mechanical damage Leakage current $\leq 200 \mu\text{A}$	500 hr at 40°C and 90~95% RH with working voltage applied	MIL-STD-202 Method 103 IEC 60068-2-3 CECC 42000
12	ESD contact test*	Varistor voltage change >115% working voltage	Contact electrostatic discharge 100 times with 1 second intervals at 8KV (Level 4) and polarity: +,-	IEC 61000-4-2
13	ESD air test*	Varistor voltage change >115% working voltage	Air contact electrostatic discharge 100 times with 1 second intervals at 15KV (Level 4) and polarity: +,-	IEC 61000-4-2

* For ES series only.

Packaging

Tape Dimensions

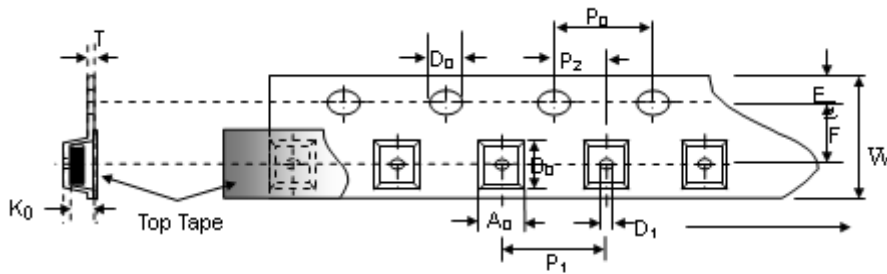

Direction of unreeling

Unit : mm

Symbol	A ₀ ±0.10	B ₀ ±0.10	K ₀ ±0.10	T ±0.05	D ₀ +0.10 -0.00	D ₁ ±0.05	P ₁ ±0.10	P ₂ ±0.05	P ₀ ±0.05	W ±0.20	E ±0.10	F ±0.05
0402	0.85	1.25	0.65	0.22	1.50	1.00	3.00	2.00	4.00	8.00	1.75	3.50
0603	1.05	1.88	0.95	0.22	1.50	1.00	4.00	2.00	4.00	8.00	1.75	3.50
0805	1.42	2.30	1.25	0.22	1.50	1.00	4.00	2.00	4.00	8.00	1.75	3.50
1206	1.88	3.50	1.55	0.22	1.50	1.00	4.00	2.00	4.00	8.00	1.75	3.50
1210	2.78	3.46	1.55	0.22	1.50	1.00	4.00	2.00	4.00	8.00	1.75	3.50
1812	3.66	4.95	2.20	0.25	1.50	1.50	8.00	2.00	4.00	12.00	1.75	5.50
2220	5.10	5.97	2.80	0.25	1.50	1.50	8.00	2.00	4.00	12.00	1.75	5.50

Reel Dimensions

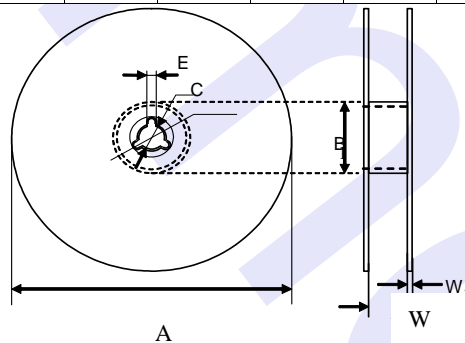

Unit : mm

Symbol	A	B	C	D	E	W	W1
0402	178.0±1.0	60.0±0.5	13.0±0.2	21.0±0.2	2.0±0.5	9.0±0.5	1.5±0.15
0603	178.0±1.0	60.0±0.5	13.0±0.2	21.0±0.2	2.0±0.5	9.0±0.5	1.5±0.15
0805	178.0±1.0	60.0±0.5	13.0±0.2	21.0±0.2	2.0±0.5	9.0±0.5	1.5±0.15
1206	178.0±1.0	60.0±0.5	13.0±0.2	21.0±0.2	2.0±0.5	9.0±0.5	1.5±0.15
1210	178.0±1.0	60.0±0.5	13.0±0.2	21.0±0.2	2.0±0.5	9.0±0.5	1.5±0.15
1812	178.0±1.0	60.0±0.5	13.5±0.1	21.0±0.2	2.0±0.5	13.6±0.2	1.5±0.15
2220	178.0±1.0	60.0±0.5	13.5±0.1	21.0±0.2	2.0±0.5	13.6±0.2	1.5±0.15

Pieces Packaged Per Reel

Size	0402	0603	0805	1206	1210	1812	2220
Pcs/reel	10000	4000	3000	3000	2000	1000	1000

Storage

The maximum ambient temperature shall not exceed 40°C and the maximum relative humidity shall not exceed 70%.

Recommended Soldering Temperature Profiles

1. Vapor Phase Soldering Profile

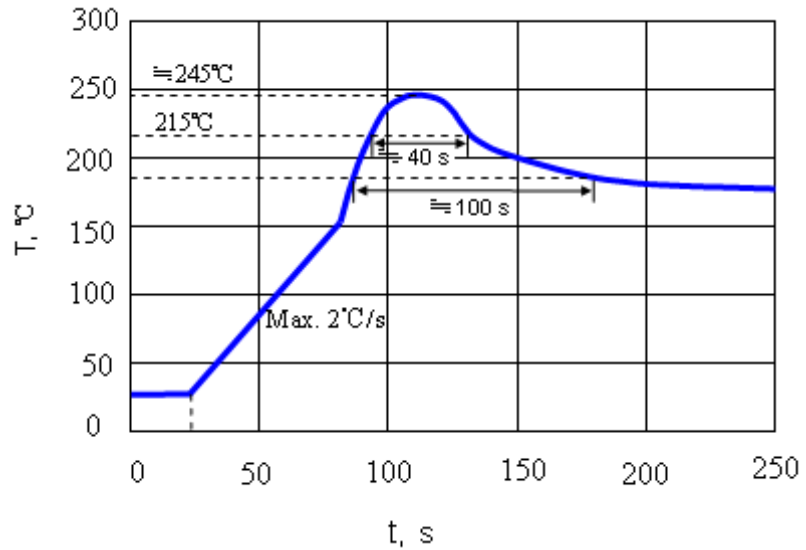

2. Reflow Soldering Profile

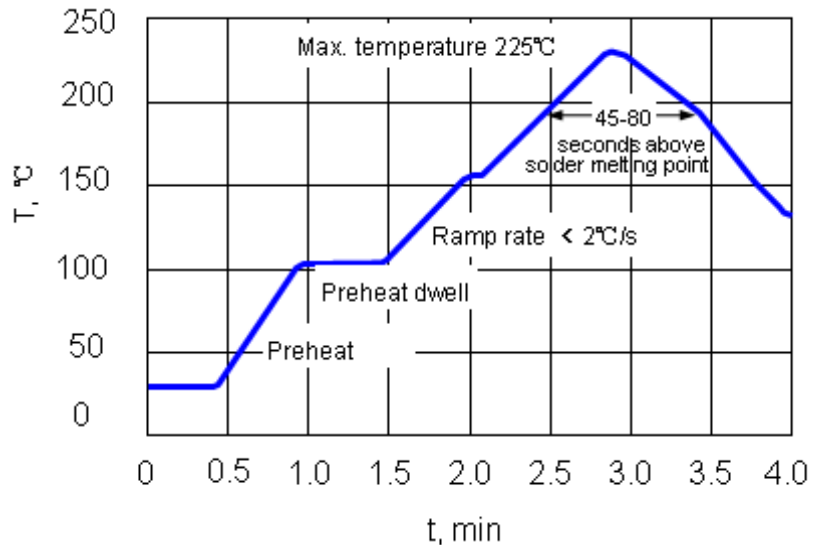

3. Reflow Soldering Profile

